

Name: \_\_\_\_\_

# -and

Write the words.

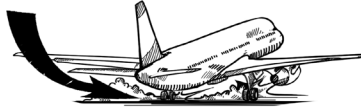

\_\_\_\_\_

-----

\_\_\_\_\_

Color only the "and" words.

tumb

grand

brand

slid

fund

land

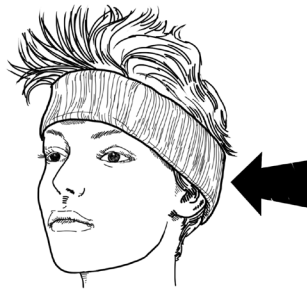

\_\_\_\_\_

-----

\_\_\_\_\_

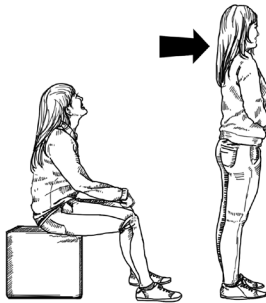

\_\_\_\_\_

-----

\_\_\_\_\_

Color only the "and" words.

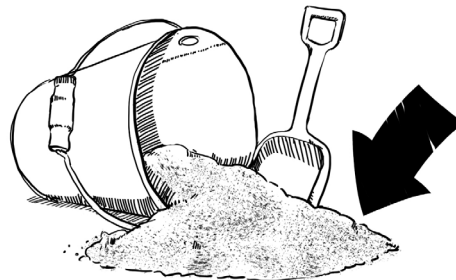
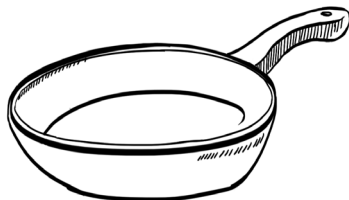
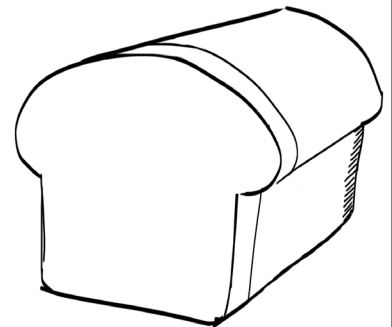
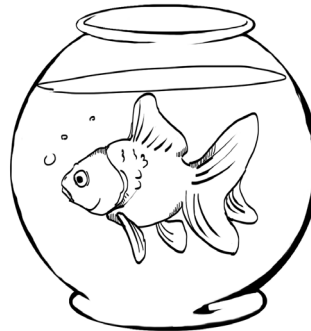
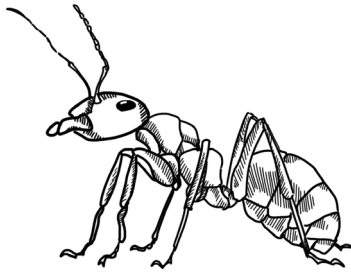

# ANSWER KEY

# -and

Write the words.

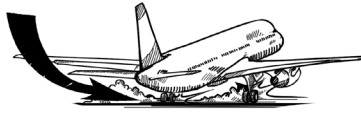

land

Color only the "and" words.

tumb

grand

brand

slid

fund

land

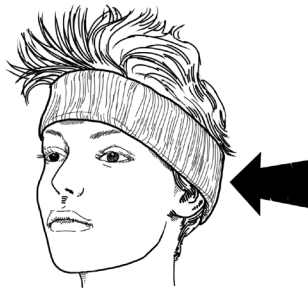

band

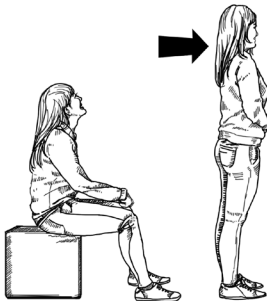

stand

Color only the "and" words.

